

OCLOVIS

INSTALLATION MANUAL

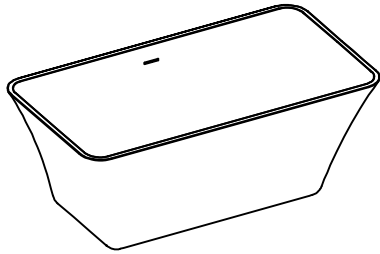

STEP 1

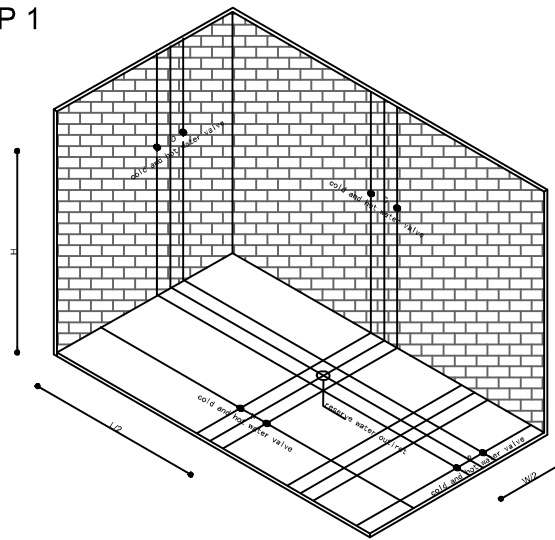

1. Before installation, please confirm the installation position of bathtub, reserve the position of hot and cold water valve and water outlet.

STEP 2

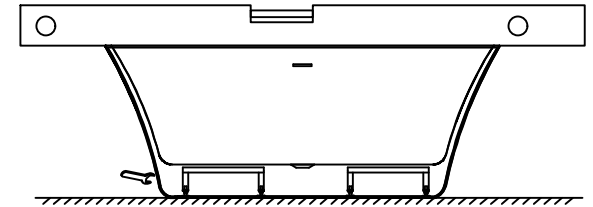

1. After placing the bathtub in the reserved position, use the spirit level to adjust the support nut until the bathtub is placed horizontally. Please keep a gap of 3-5mm between the edge of the bathtub and the wall.

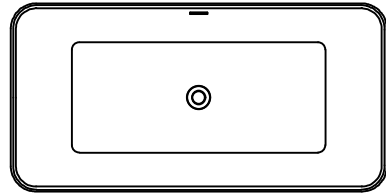

STEP 3

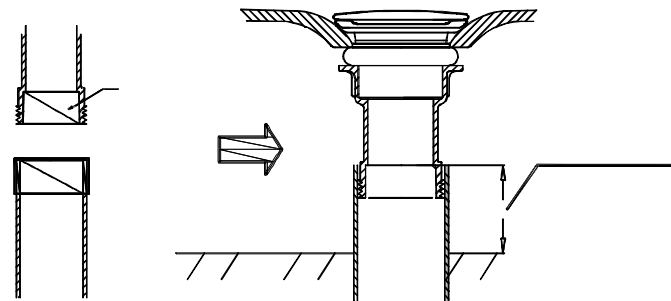

1. Insert the outlet pipe into the sewer pipe. If the outlet pipe is too short, please connect it with a tube before inserting.

STEP 4



Notes on the usage of freestanding bathtub

1. Please do not hit the bathtub with hard objects or drop hard objects from the elevation into the bathtub.
 2. No adding boiling water directly into the bathtub. Please put cold water first, then hot water. Pay attention to avoiding storing bathtubs above 80 degrees, because acrylic products will begin to soften when heated at 100 degrees.
 3. Power-on bulb, naked flame, high temperature object, please do not place them in the bathtub, otherwise it will leave scars or cause deformation of the bathtub. Strong organic solvent such as paints, volatile agents, thinners, please do not contact with bathtub to avoid surface softening, dissolution, cracking, etc., which may endanger product quality.
 4. Avoid wiping with cleanser. Cleanser will corrode the surface and reduce brightness.
 5. The hardness of acrylic is equivalent to aluminum, so please pay attention to the surface protection. It's inevitable that the surface of bathtubs will be scratched in the daily use of friction. It can be repaired with above 1500# abrasive paper, and the bright surface can be obtained with automotive polishing agent.
- Please wipe off the surface with a cloth which is dry and soft to keep the bathtub clean.

Spirit level

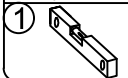

Pencil

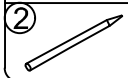

Spanner

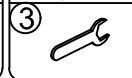

Tapeline

